

INSTALLATION SHEET

SP

Safety, Warnings and Suggestions

- ¹ **Avoid** installing fixtures in locations where water collects and stands for prolonged periods.
- ² **Make** sure that electrical power is disconnected before any work is performed.
- ³ **All** wiring and installation should meet local, state and national electrical codes.

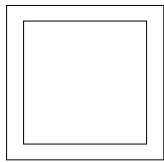

SP-105

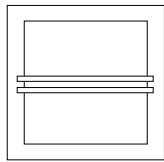

SP-106

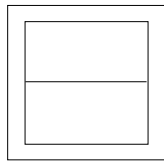

SP-107

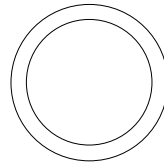

SP-108

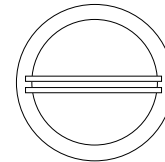

SP-109

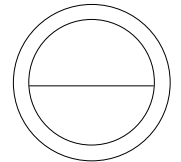

SP-110

P# 37437

© 2005 - 2008 ALLSCAPE. All rights reserved.
 ALLSCAPE is a registered trademark of Philips.

Due to a program of continuous improvement, ALLSCAPE reserves the right to make any variation in design or construction to the equipment described.

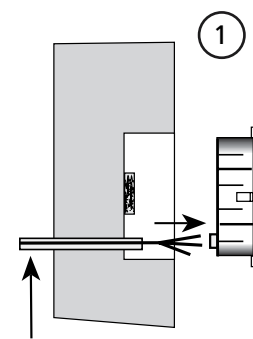

Conduit By Others

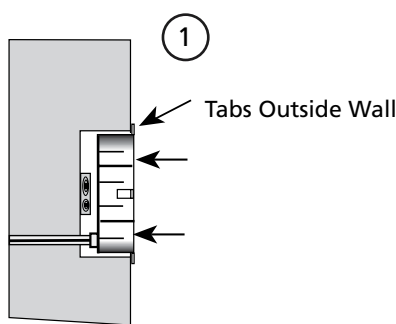

1 Tabs Outside Wall

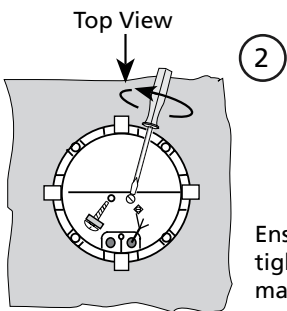

Top View

2 Ensure a water tight seal is made.

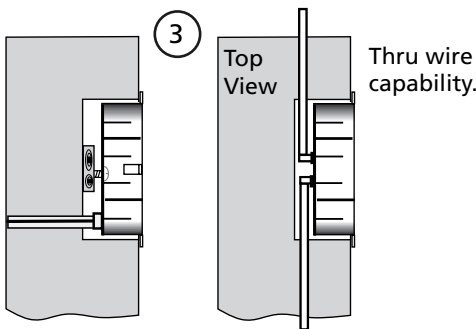

3 Top View Thru wire capability.

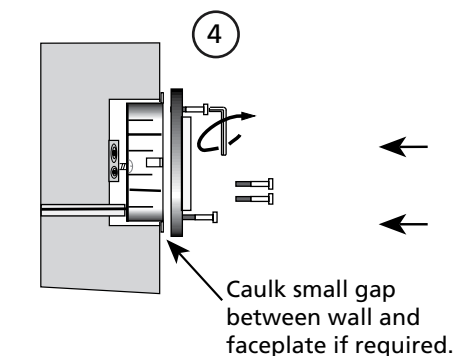

4 Caulk small gap between wall and faceplate if required.

1) Attach wood block to rear of wall opening. Connect conduit to provisions provided at rear of back box. Make sure outside tabs are flush to wall surface.

2) Attach back box to wood block with (2) #10 wood screws.

3) Make all necessary wire connections using UL listed wire nuts.

4) Install faceplate onto back box using socket head cap screws provided.